

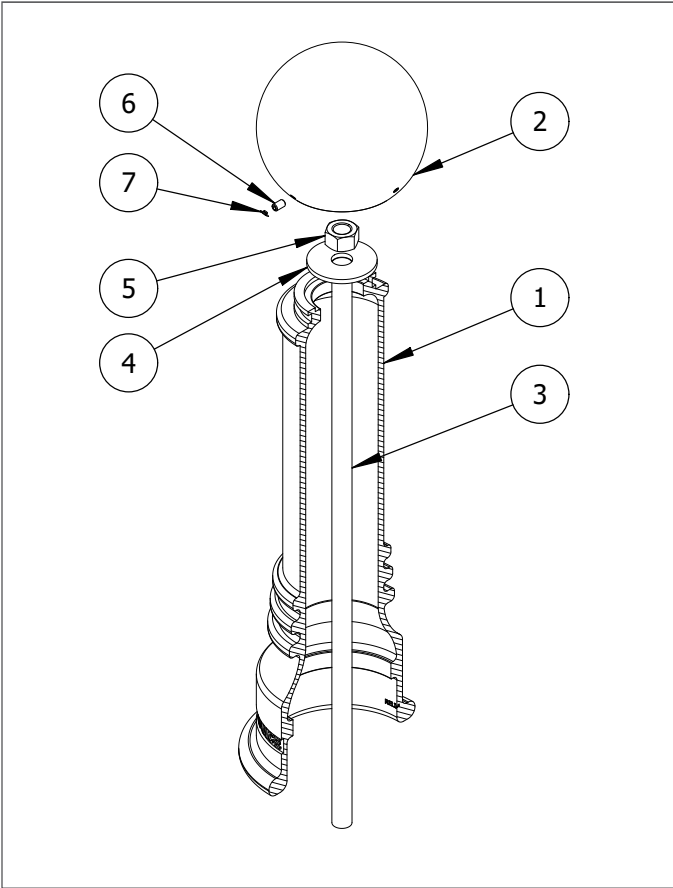



# R-7555 Decorative Bollard Installation

## Adhesive Anchoring



-  To protect the finish, keep bollards in original packaging until exact moment of installation.
-  Handle with care to avoid scratching or damaging bollard surfaces as abrasions will lead to rust.
-  Once scratched, bollards cannot be repaired to original form without re-finishing the entire surface.

### Before Installation

- STEP 1:** Always check for hazards such as water pipes, gas lines, and underground wiring before drilling.
- STEP 2:** Use a broom or pressure washer to clean the concrete surface prior to bollard installation.
- STEP 3:** Study the site plans to locate and mark the precise center point of each bollard. For secure installation, ensure there is a minimum radius\*\* of solid concrete around each mark.

### Drill the Hole

- STEP 4:** Tap a pilot divot hole in the center of each mark.
- STEP 5:** Set the depth control on the hammer drill (or rotary hammer) to 4". If depth control is not available, mark 4" on the masonry bit.
- STEP 6:** Drill a hole that has a 1-1/8" diameter and 4" depth. Drill on high speed, using the hammer function if available.

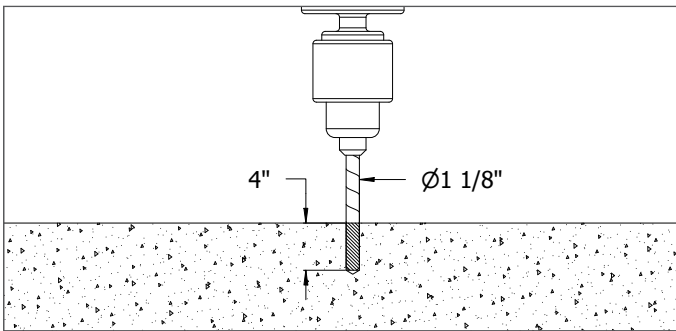

*\*Please refer to the adhesive manufacturer's MSDS (included in shipment) before using.*

*\*\*Adhesive anchor manufacturers such as [www.powers.com](http://www.powers.com) recommend a minimum radius of 5".*

### Parts List

#	PART	QTY
1	Bollard Base	1
2	Bollard Cap	1
3	Threaded Bar 1"	1
4	Washer 1"	1
5	Hex Nut 1"	1
6	Hexagon Socket Set Screw	3
7	Plastic Plug	3

### Installation Equipment

1-1/8" Masonry Drill Bit	Chalk
1-1/2" Wrench	Caulking Gun
3/16" Hex Key	Level
Hammer Drill or Rotary Hammer	Measuring Tape
Adhesive Anchoring System* (included)	

# R-7555 Decorative Bollard Installation

## Adhesive Anchoring

STEP 8

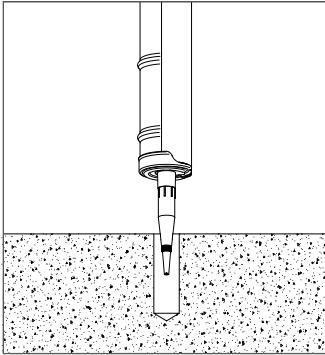

STEP 11

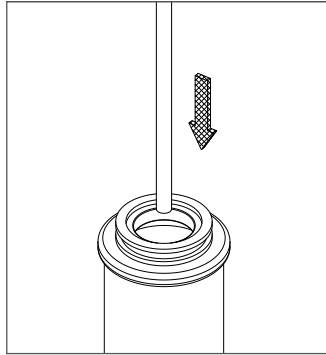

STEP 12

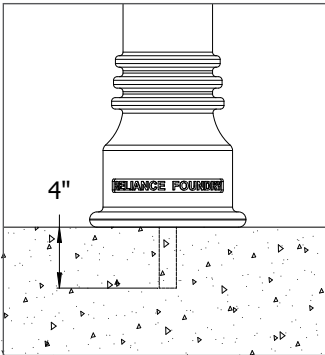

STEP 13

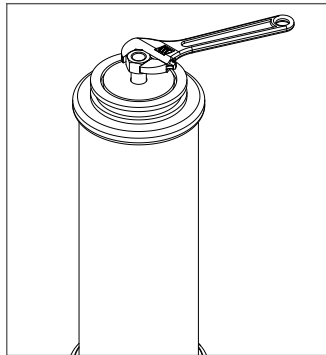

STEP 14

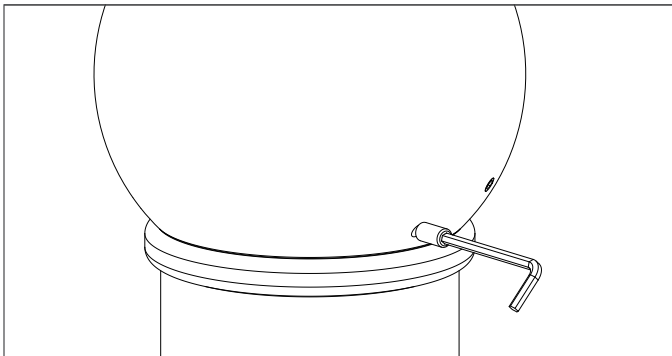

STEP 15

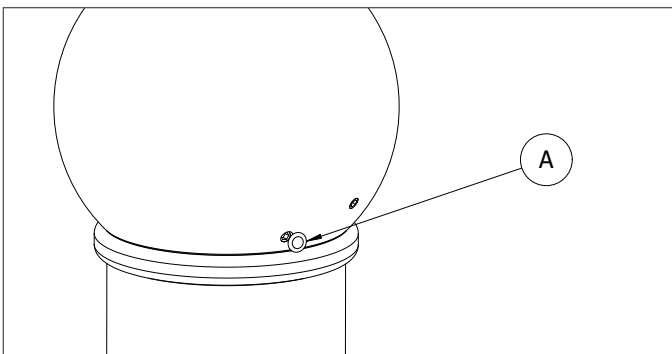

### Secure the Bollard

**STEP 7:** Clear the hole of all debris and/or standing water using the vacuum. Use a brush to remove any remaining loose particles.

**STEP 8:** Using the caulk gun, dispense the adhesive from the bottom up until the hole is one-quarter full. Prevent air pockets by withdrawing the mixing nozzle slowly.

**STEP 9:** Carefully place the bollard near the installation position. When ready to install, remove its protective packaging.

**STEP 10:** Set the bollard base upright and maneuver it so the center lines up with the drilled hole.

**STEP 11:** Lower the threaded rod through the top of the bollard and into the drilled hole.

**STEP 12:** Insert the threaded rod the full 4" into the drilled hole while turning for positive adhesion. The rod should be centered in the bollard's shaft. *Note: A minimum of 45 minutes at 68°F is required for the anchoring system to set.*

**STEP 13:** Place the washer over the threaded rod so it rests on top of the bollard base. Apply the 1" nut to the threaded rod and use a wrench to tighten until the bollard is secure.

**STEP 14:** Remove the bollard cap from packaging and place on top of the shaft of the bollard. Secure and align the bollard cap to the bollard base with the three set screws. Tighten in equal amounts to ensure the cap remains centered.

**STEP 15:** Place the plastic plugs (A) over the heads of the set screws.



**Inspect the installation.** Abrasions should be covered as soon as possible. For damage repair or other servicing needs, please contact Reliance Foundry's sales department.