

Bollard Cover R-7313

General Description:

R-7313 Stainless Steel Bollard Covers offer the most versatile protection for posts under 10-3/4 inches in diameter. Increase visibility and aesthetics of steel pipe security posts, while ensuring protection from wear and corrosion. 4 installation types available: Spray foam adhesive, set screws, top hanger, or J hanger. Covers are made from corrosion-resistant 316 stainless steel and features a dome top. Optional powder coating is available in 1 of 6 custom colors.

Specifications:

Height: 42"
 Base Diameter: 12 13/16"
 Weight: 80 lbs (Bollard Only)
 Material: Stainless Steel 316
 Max. Interior Security Post Size:
 10 3/4" x 40" (Diameter x Height)

Finish Options:

- Satin #6 Buffed
- Polyester Powdercoated (Additional service charge)

See Reliance Foundry's standard color options at:
www.reliance-foundry.com/bollard/colors-bollards

Installation Options:

- Set Screw Installation Option
(see sheet 2 of 5)
- Adhesive Foam Installation Option
(see sheet 3 of 5)
- Top Hanger Installation in Existing Concrete
(see sheet 4 of 5)
- J Hanger Installation in New Concrete
(see sheet 5 of 5)

For more information on bollard post installation, please visit:
www.reliance-foundry.com/bollard/installation-bollards

Care and Maintenance:

Despite its natural anti-corrosion properties, stainless steel may corrode if cautionary procedures are not followed, or if products are neglected for extended periods of time. High-saline environments or other areas with high exposure to chlorides may increase risk of stainless steel corrosion. Regular cleaning will maintain optimal condition and appearance.

See Reliance Foundry's maintenance guide at:
www.reliance-foundry.com/bollard/stainless-steel-maintenance

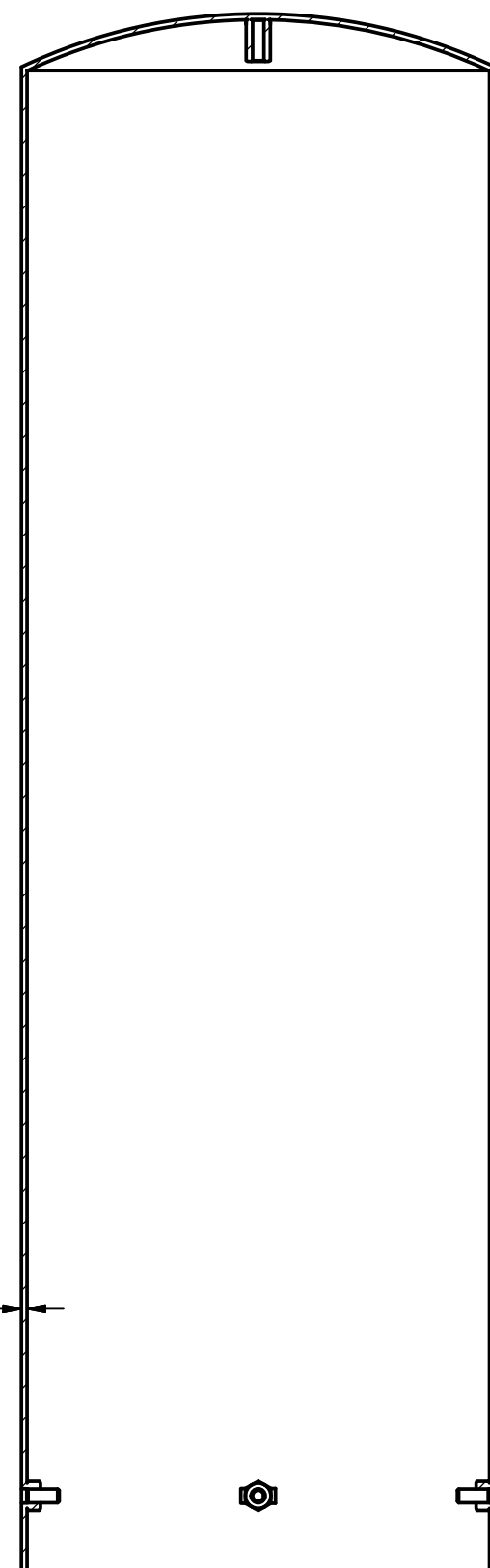

SECTION A-A

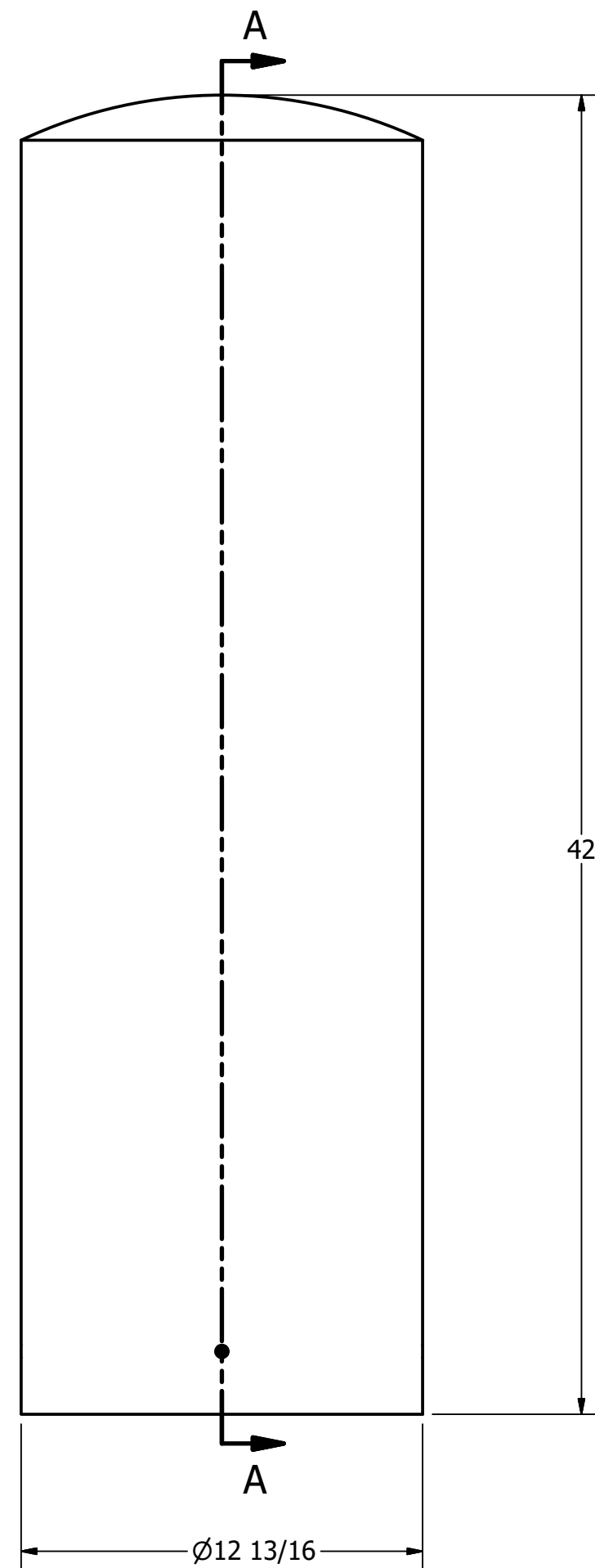

RELIANCE FOUNDRY
 SINCE 1925

Unit 207, 6450 - 148 Street, Surrey, BC V3S 7G7, Canada
 1-888-735-5680 info@reliance-foundry.com
www.reliance-foundry.com

TITLE			
Bollard Cover R-7313			
SIZE	DWG NO	REV	
C	R7313	C	
NOT TO SCALE		SHEET 1 OF 5	

Bollard Cover R-7313

General Description:

R-7313 Stainless Steel Bollard Covers offer the most versatile protection for posts under 10-3/4 inches in diameter. Increase visibility and aesthetics of steel pipe security posts, while ensuring protection from wear and corrosion. 4 installation types available: Spray foam adhesive, set screws, top hanger, or J hanger. Covers are made from corrosion-resistant 316 stainless steel and features a dome top. Optional powder coating is available in 1 of 6 custom colors.

Specifications:

Height: 42"
 Base Diameter: 12 13/16"
 Weight: 80 lbs (Bollard Only)
 Material: Stainless Steel 316
 Max. Interior Security Post Size:
 10 3/4" x 40" (Diameter x Height)

Finish Options:

- ⊙ Satin #6 Buffed
- Polyester Powdercoated (Additional service charge)

See Reliance Foundry's standard color options at:
www.reliance-foundry.com/bollard/colors-bollards

Installation Options:

- ⊙ Set Screw Installation Option (see sheet 2 of 5)
- Adhesive Foam Installation Option (see sheet 3 of 5)
- Top Hanger Installation in Existing Concrete (see sheet 4 of 5)
- J Hanger Installation in New Concrete (see sheet 5 of 5)

For more information on bollard post installation, please visit:
www.reliance-foundry.com/bollard/installation-bollards

Care and Maintenance:

Despite its natural anti-corrosion properties, stainless steel may corrode if cautionary procedures are not followed, or if products are neglected for extended periods of time. High-saline environments or other areas with high exposure to chlorides may increase risk of stainless steel corrosion. Regular cleaning will maintain optimal condition and appearance.

See Reliance Foundry's maintenance guide at:
www.reliance-foundry.com/bollard/stainless-steel-maintenance

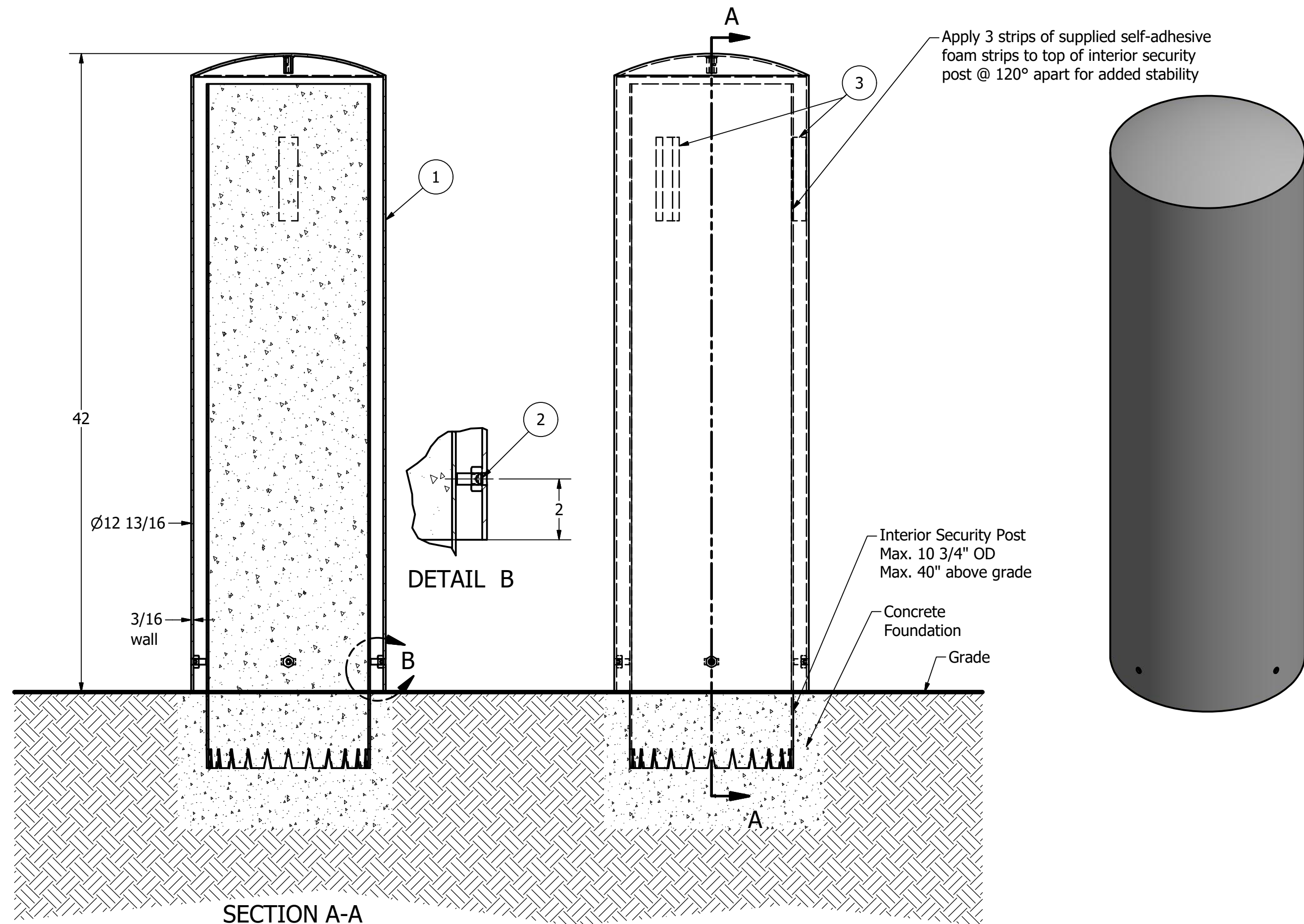

Set Screw Installation Option

Notes:

- 1) Bollard cover is provided as shown. Concrete, foundation and/or installation ordered separately or provided by others.
- 2) Minimum foundation sizes depend on local soil conditions, weather conditions, and engineering requirements.
- 3) Dimensions provided herein is for reference only. Please consult Reliance Foundry sales professionals if any dimension is critical to your particular installation.
- 4) Reliance Foundry reserves the right to amend design and specifications without prior notice for product improvement.

PARTS LIST

ITEM	QTY	PART NUMBER	DESCRIPTION	MATERIAL	WEIGHT
1	1	R7313 Bollard Cover	R7313 Stainless Steel Bollard Cover	Stainless Steel 316	80 lbs
2	4	Hexagon Socket Set Screw 3/8" x 7/8"	Hexagon Socket Set Screw 3/8" x 7/8" - requires 3/16" hex key	Stainless Steel	
3	3	Foam Strip	Self-adhesive Neoprene Foam Strip	Synthetic Rubber	

RELIANCE FOUNDRY
 SINCE 1925

Unit 207, 6450 - 148 Street, Surrey, BC V3S 7G7, Canada
 1-888-735-5680 info@reliance-foundry.com
www.reliance-foundry.com

TITLE

Bollard Cover R-7313

SIZE
C

DWG NO
R7313

REV
C

Bollard Cover R-7313

General Description:

R-7313 Stainless Steel Bollard Covers offer the most versatile protection for posts under 10-3/4 inches in diameter. Increase visibility and aesthetics of steel pipe security posts, while ensuring protection from wear and corrosion. 4 installation types available: Spray foam adhesive, set screws, top hanger, or J hanger. Covers are made from corrosion-resistant 316 stainless steel and features a dome top. Optional powder coating is available in 1 of 6 custom colors.

Specifications:

Height: 42"
 Base Diameter: 12 13/16"
 Weight: 80 lbs (Bollard Only)
 Material: Stainless Steel 316
 Max. Interior Security Post Size:
 10 3/4" x 40" (Diameter x Height)

Finish Options:

- ⊙ Satin #6 Buffed
- Polyester Powdercoated (Additional service charge)

See Reliance Foundry's standard color options at:
www.reliance-foundry.com/bollard/colors-bollards

Installation Options:

- Set Screw Installation Option (see sheet 2 of 5)
- ⊙ Adhesive Foam Installation Option (see sheet 3 of 5)
- Top Hanger Installation in Existing Concrete (see sheet 4 of 5)
- J Hanger Installation in New Concrete (see sheet 5 of 5)

For more information on bollard post installation, please visit:
www.reliance-foundry.com/bollard/installation-bollards

Care and Maintenance:

Despite its natural anti-corrosion properties, stainless steel may corrode if cautionary procedures are not followed, or if products are neglected for extended periods of time. High-saline environments or other areas with high exposure to chlorides may increase risk of stainless steel corrosion. Regular cleaning will maintain optimal condition and appearance.

See Reliance Foundry's maintenance guide at:
www.reliance-foundry.com/bollard/stainless-steel-maintenance

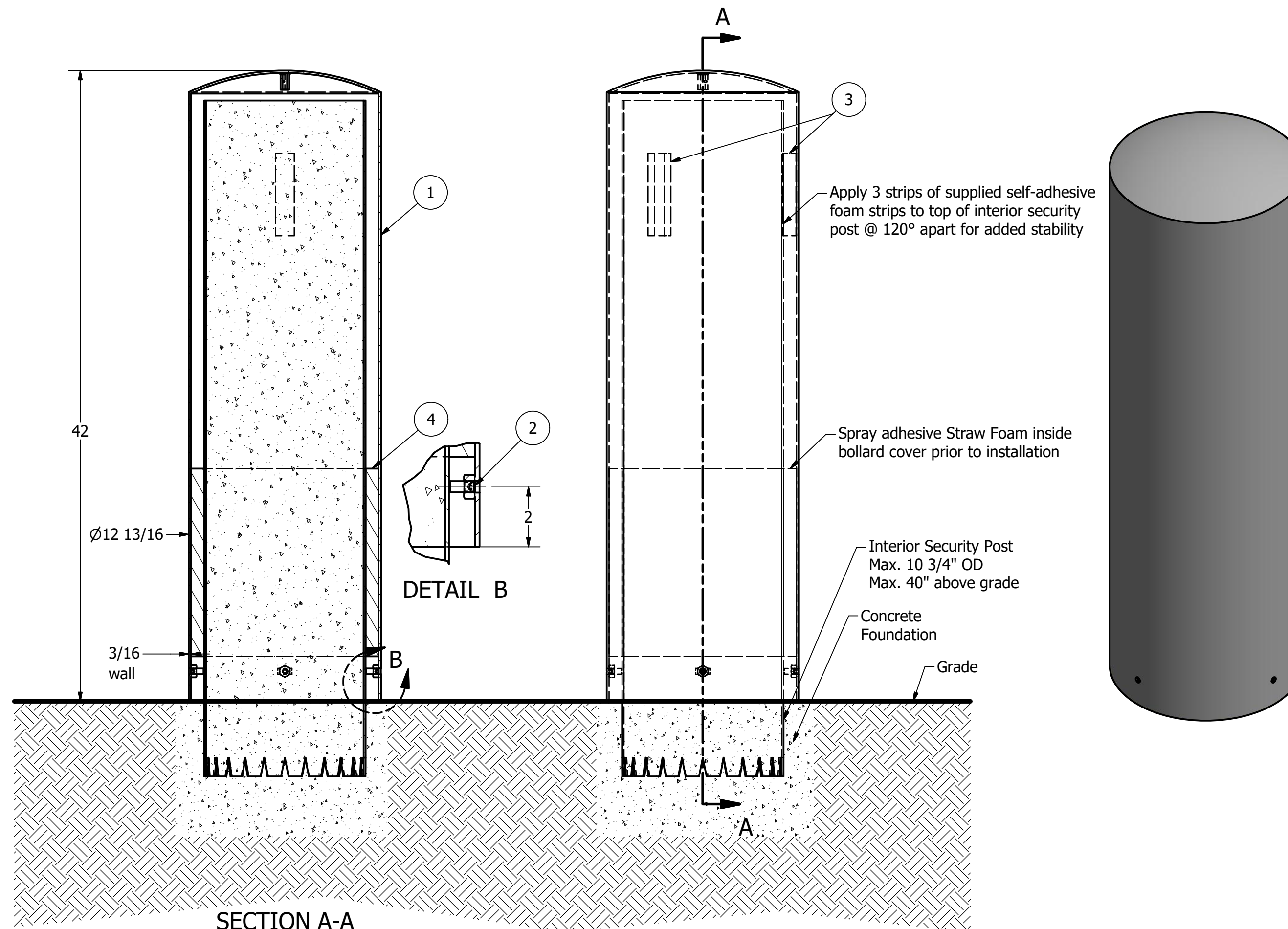

Adhesive Foam Installation Option

Notes:

- 1) Bollard cover is provided as shown. Concrete, foundation and/or installation ordered separately or provided by others.
- 2) Minimum foundation sizes depend on local soil conditions, weather conditions, and engineering requirements.
- 3) Dimensions provided herein is for reference only. Please consult Reliance Foundry sales professionals if any dimension is critical to your particular installation.
- 4) Reliance Foundry reserves the right to amend design and specifications without prior notice for product improvement.

PARTS LIST

ITEM	QTY	PART NUMBER	DESCRIPTION	MATERIAL	WEIGHT
1	1	R7313 Bollard Cover	R7313 Stainless Steel Bollard Cover	Stainless Steel 316	80 lbs
2	4	Hexagon Socket Set Screw 3/8" x 7/8"	Hexagon Socket Set Screw 3/8" x 7/8" - requires 3/16" hex key	Stainless Steel	
3	3	Foam Strip	Self-adhesive Neoprene Foam Strip	Synthetic Rubber	
4	1	Straw Foam	PF-50 UltraSeal Straw Foam	Polyurethane Foam	

COPYRIGHT RESERVED THIS PLAN DRAWING AND DESIGN ARE, AND AT ALL TIMES REMAIN, THE EXCLUSIVE PROPERTY OF RELIANCE FOUNDRY CO. LTD.

RELIANCE FOUNDRY
 SINCE 1925

Unit 207, 6450 - 148 Street, Surrey, BC V3S 7G7, Canada
 1-888-735-5680 info@reliance-foundry.com
www.reliance-foundry.com

Bollard Cover R-7313

SIZE C	DWG NO R7313	REV C
------------------	------------------------	-----------------

NOT TO SCALE SHEET 3 OF 5

Bollard Cover R-7313

General Description:

R-7313 Stainless Steel Bollard Covers offer the most versatile protection for posts under 10-3/4 inches in diameter. Increase visibility and aesthetics of steel pipe security posts, while ensuring protection from wear and corrosion. 4 installation types available: Spray foam adhesive, set screws, top hanger, or J hanger. Covers are made from corrosion-resistant 316 stainless steel and features a dome top. Optional powder coating is available in 1 of 6 custom colors.

Specifications:

Height: 42"
 Base Diameter: 12 13/16"
 Weight: 80 lbs (Bollard Only)
 Material: Stainless Steel 316
 Max. Interior Security Post Size:
 10 3/4" x 40" (Diameter x Height)

Finish Options:

- Satin #6 Buffed
- Polyester Powdercoated (Additional service charge)

See Reliance Foundry's standard color options at:
www.reliance-foundry.com/bollard/colors-bollards

Installation Options:

- Set Screw Installation Option (see sheet 2 of 5)
- Adhesive Foam Installation Option (see sheet 3 of 5)
- Top Hanger Installation in Existing Concrete (see sheet 4 of 5)
- J Hanger Installation in New Concrete (see sheet 5 of 5)

For more information on bollard post installation, please visit:
www.reliance-foundry.com/bollard/installation-bollards

Care and Maintenance:

Despite its natural anti-corrosion properties, stainless steel may corrode if cautionary procedures are not followed, or if products are neglected for extended periods of time. High-saline environments or other areas with high exposure to chlorides may increase risk of stainless steel corrosion. Regular cleaning will maintain optimal condition and appearance.

See Reliance Foundry's maintenance guide at:
www.reliance-foundry.com/bollard/stainless-steel-maintenance

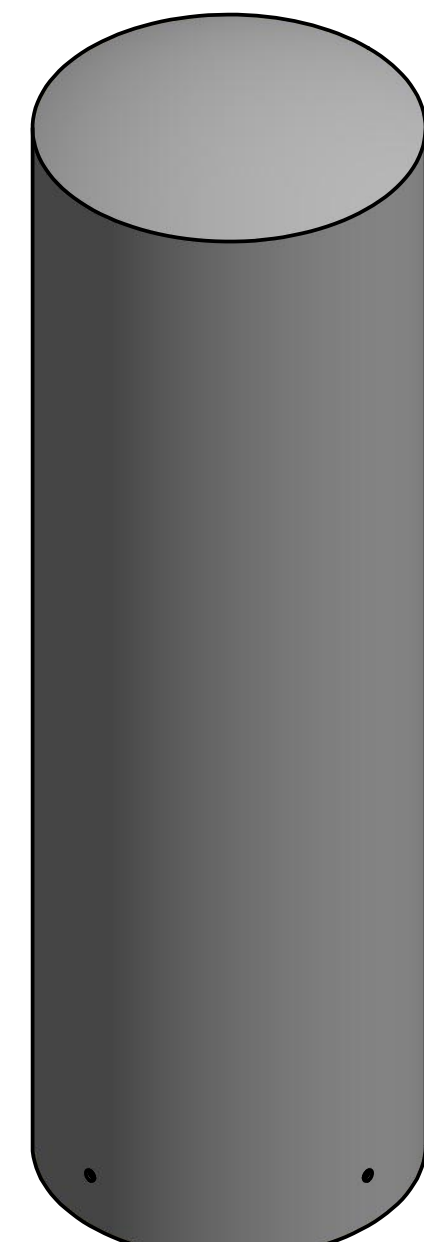

- 1) Use hammer drill to make hole 1/2" dia. x 3" depth
- 2) Clean drill hole of debris
- 3) Caulk Adhesive into hole from bottom up and fill 2/3 full
- 4) Push Hanger Bar into Adhesive and turn to ensure bonding
- 5) Adjust to ensure bollard cover is perpendicular and flush to grade
- 6) Wait at least 45 minutes for Adhesive to cure

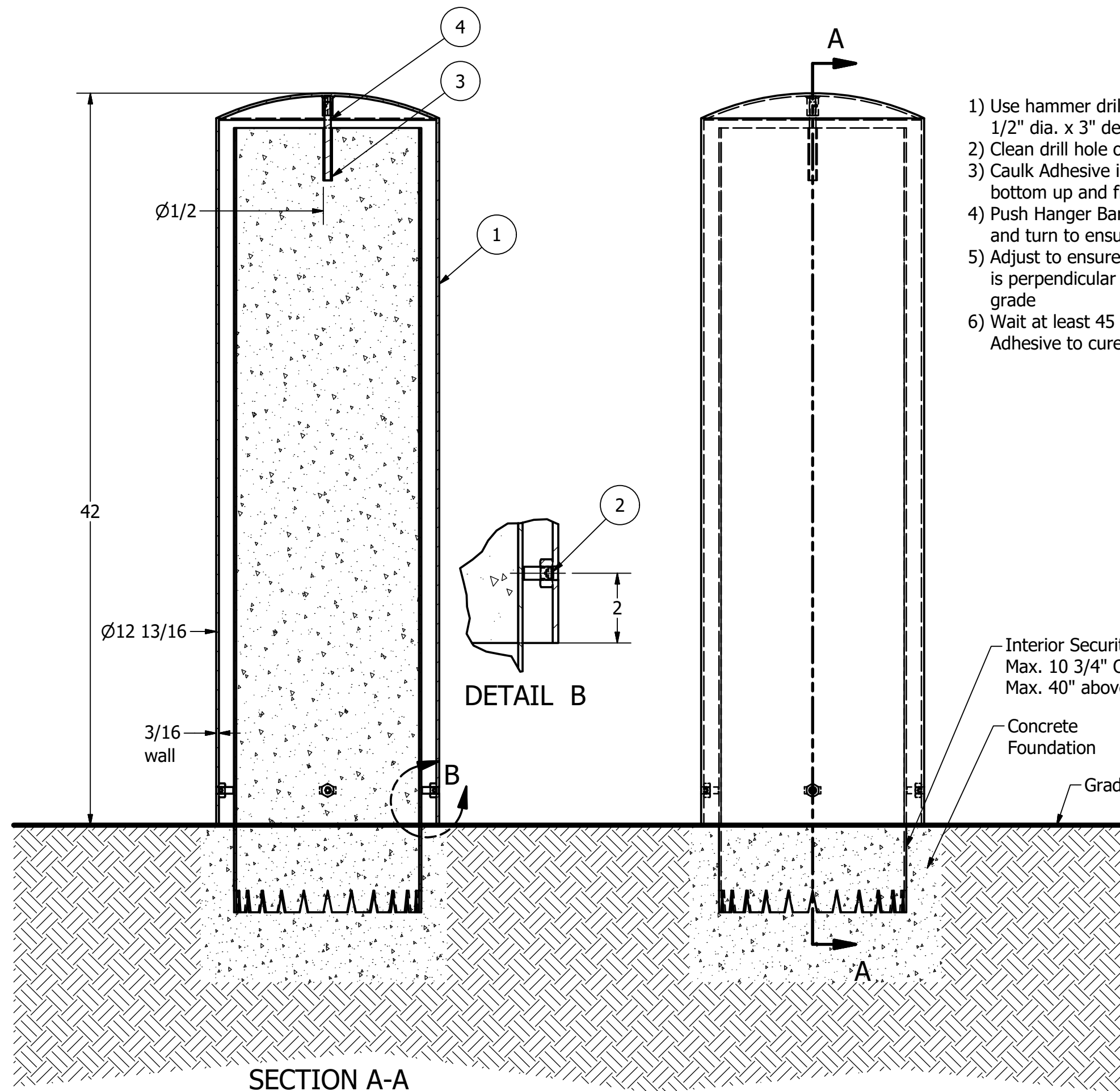
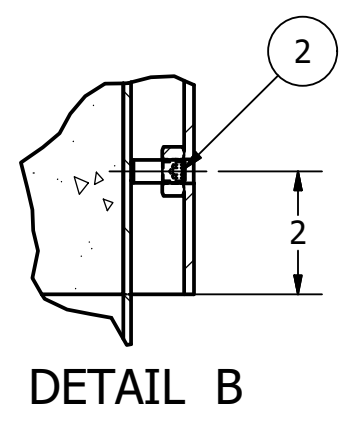

Top Hanger Installation in Existing Concrete

Notes:

- 1) Bollard cover is provided as shown. Concrete, foundation and/or installation ordered separately or provided by others.
- 2) Minimum foundation sizes depend on local soil conditions, weather conditions, and engineering requirements.
- 3) Dimensions provided herein is for reference only. Please consult Reliance Foundry sales professionals if any dimension is critical to your particular installation.
- 4) Reliance Foundry reserves the right to amend design and specifications without prior notice for product improvement.

PARTS LIST

ITEM	QTY	PART NUMBER	DESCRIPTION	MATERIAL	WEIGHT
1	1	R7313 Bollard Cover	R7313 Stainless Steel Bollard Cover	Stainless Steel 316	80 lbs
2	4	Hexagon Socket Set Screw 3/8" x 7/8"	Hexagon Socket Set Screw 3/8" x 7/8" - requires 3/16" hex key	Stainless Steel	
3	1	Adhesive Anchor	AC100+ Gold Adhesive Anchoring System	Vinylester Adhesive Mortar	5/8 lbs
4	1	R7300 HANGER 3/8"	R7300 Top Hanger 3/8" Custom Order Length	Steel	1/8 lbs

RELIANCE FOUNDRY
 SINCE 1925

Unit 207, 6450 - 148 Street, Surrey, BC V3S 7G7, Canada
 1-888-735-5680 info@reliance-foundry.com
www.reliance-foundry.com

TITLE

Bollard Cover R-7313

SIZE
C

DWG NO
R7313

REV
C

COPYRIGHT RESERVED THIS PLAN DRAWING AND DESIGN ARE, AND AT ALL TIMES REMAIN, THE EXCLUSIVE PROPERTY OF RELIANCE FOUNDRY CO. LTD.

NOT TO SCALE

SHEET 4 OF 5

Bollard Cover R-7313

General Description:

R-7313 Stainless Steel Bollard Covers offer the most versatile protection for posts under 10-3/4 inches in diameter. Increase visibility and aesthetics of steel pipe security posts, while ensuring protection from wear and corrosion. 4 installation types available: Spray foam adhesive, set screws, top hanger, or J hanger. Covers are made from corrosion-resistant 316 stainless steel and features a dome top. Optional powder coating is available in 1 of 6 custom colors.

Specifications:

Height: 42"
 Base Diameter: 12 13/16"
 Weight: 80 lbs (Bollard Only)
 Material: Stainless Steel 316
 Max. Interior Security Post Size:
 10 3/4" x 40" (Diameter x Height)

Finish Options:

- Satin #6 Buffed
- Polyester Powdercoated (Additional service charge)

See Reliance Foundry's standard color options at:
www.reliance-foundry.com/bollard/colors-bollards

Installation Options:

- Set Screw Installation Option (see sheet 2 of 5)
- Adhesive Foam Installation Option (see sheet 3 of 5)
- Top Hanger Installation in Existing Concrete (see sheet 4 of 5)
- J Hanger Installation in New Concrete (see sheet 5 of 5)

For more information on bollard post installation, please visit:
www.reliance-foundry.com/bollard/installation-bollards

Care and Maintenance:

Despite its natural anti-corrosion properties, stainless steel may corrode if cautionary procedures are not followed, or if products are neglected for extended periods of time. High-saline environments or other areas with high exposure to chlorides may increase risk of stainless steel corrosion. Regular cleaning will maintain optimal condition and appearance.

See Reliance Foundry's maintenance guide at:
www.reliance-foundry.com/bollard/stainless-steel-maintenance

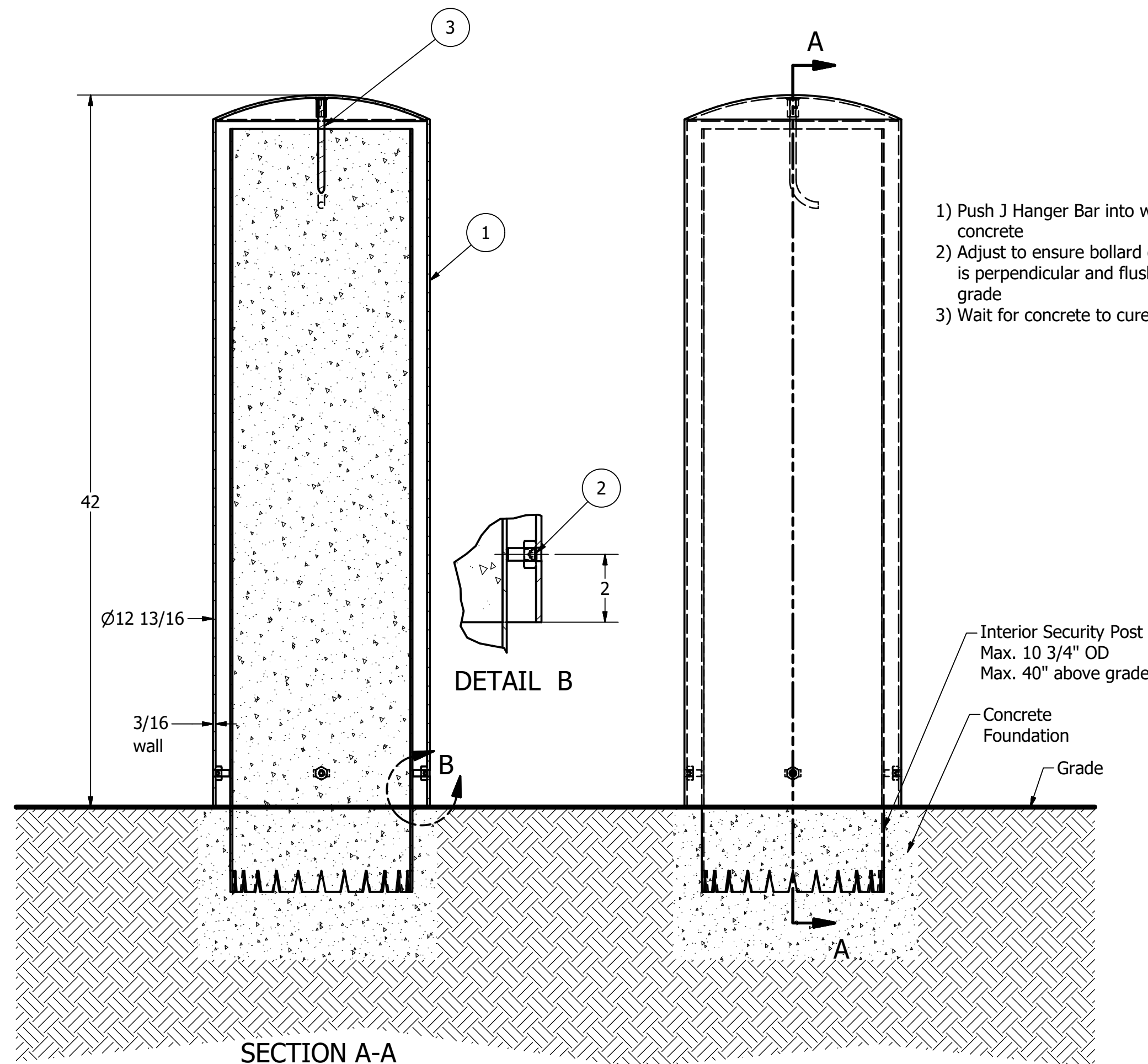

- 1) Push J Hanger Bar into wet concrete
- 2) Adjust to ensure bollard cover is perpendicular and flush to grade
- 3) Wait for concrete to cure

J Hanger Installation in New Concrete

Notes:

- 1) Bollard cover is provided as shown. Concrete, foundation and/or installation ordered separately or provided by others.
- 2) Minimum foundation sizes depend on local soil conditions, weather conditions, and engineering requirements.
- 3) Dimensions provided herein is for reference only. Please consult Reliance Foundry sales professionals if any dimension is critical to your particular installation.
- 4) Reliance Foundry reserves the right to amend design and specifications without prior notice for product improvement.

PARTS LIST

ITEM	QTY	PART NUMBER	DESCRIPTION	MATERIAL	WEIGHT
1	1	R7313 Bollard Cover	R7313 Stainless Steel Bollard Cover	Stainless Steel 316	80 lbs
2	4	Hexagon Socket Set Screw 3/8" x 7/8"	Hexagon Socket Set Screw 3/8" x 7/8" - requires 3/16" hex key	Stainless Steel	
3	1	R7300 J HANGER 3/8"	R7300 Top J Hanger 3/8" Custom Order Length	Steel	1/4 lbs

COPYRIGHT RESERVED THIS PLAN DRAWING AND DESIGN ARE, AND AT ALL TIMES REMAIN, THE EXCLUSIVE PROPERTY OF RELIANCE FOUNDRY CO. LTD.

RELIANCE FOUNDRY
 SINCE 1925

Unit 207, 6450 - 148 Street, Surrey, BC V3S 7G7, Canada
 1-888-735-5680 info@reliance-foundry.com
www.reliance-foundry.com

TITLE

Bollard Cover R-7313

SIZE
C

DWG NO
R7313

REV
C

NOT TO SCALE

SHEET 5 OF 5