

Concrete Bollard, Model R-9705-RB

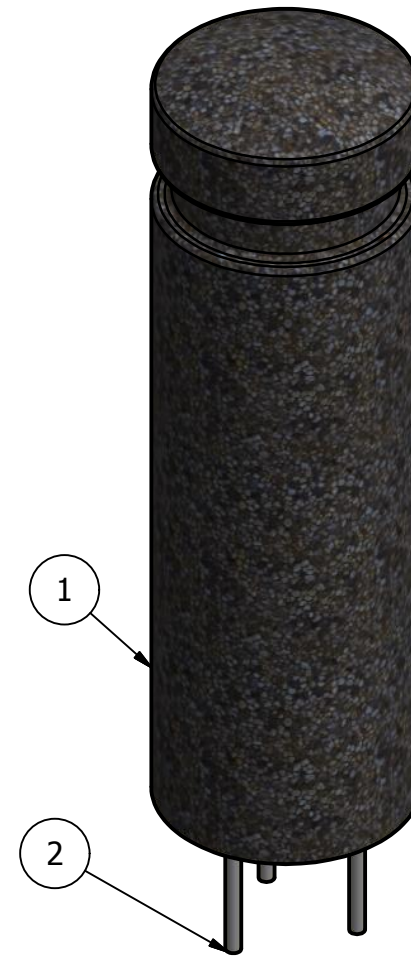
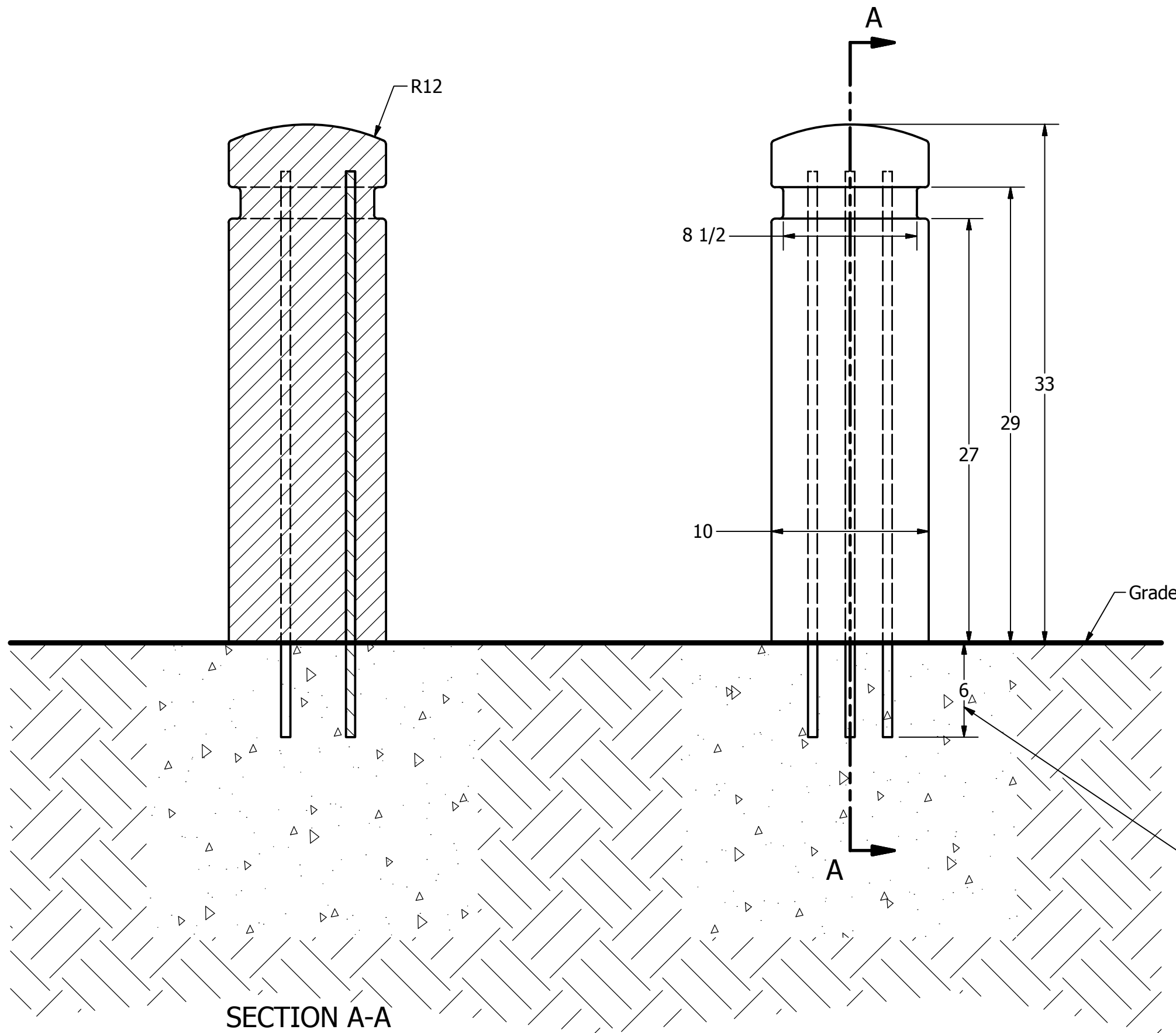

Product ships standard with 6" rebar extensions. Actual length requirements should be determined by a site engineer and requested upon ordering.

General Description:

The R-9705 Concrete Bollard features a narrow column design with clean verticals and a wide relief below a domed top. Its slim diameter makes it ideal for high-traffic pedestrian areas while offering a simple but unique aesthetic. Concrete bollards are reinforced with epoxy-coated steel rebar, and use high-pressure cement to ensure the best strength and durability against chipping and wear. Exposed aggregate finish features British Columbia granite. Install bollards by embedding rebar extensions in wet concrete--or use adhesive to secure into pre-drilled holes. Bollards ship standard with 6-inch rebar extensions and drilling template. Custom rebar lengths available.

For more information on bollard post installation, please visit: www.reliance-foundry.com/bollard/installation-bollards

Specifications:

Height: 33"

Base Diameter: 10"

Weight: 220 lbs

Material: Precast Concrete with Epoxy Coated Steel Rebar Reinforcement

Finish Options:

- Exposed aggregate

Installation Options:

- Existing Concrete: Bollards ship with fitted rebar template. Use template to drill accurate installation holes. Secure rebar in concrete with construction adhesive.
- New Concrete: Set rebar footings into wet concrete. Before installing, bend rebar outwards for more secure anchoring.

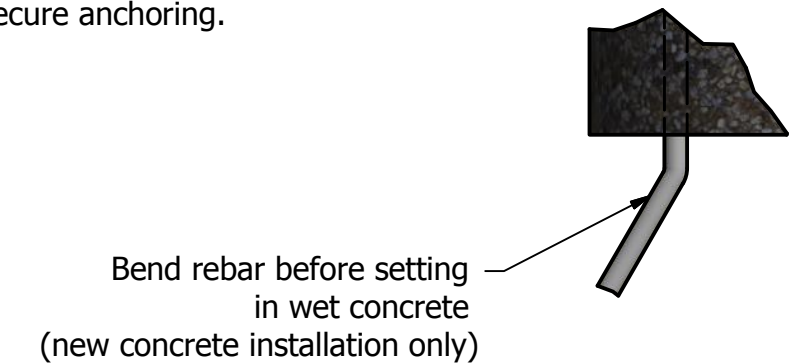

Notes:

- Embedment details are for reference illustration only. Minimum foundation sizes depend on local soil conditions, weather conditions, and engineering requirements.
- Bollard is provided as shown with parts listed below. Concrete foundation and/or installation not provided by Reliance Foundry.
- This drawing is not drawn to scale. Dimensions provided herein is for reference only. Please consult Reliance Foundry sales professionals if any dimension is critical to your particular installation.
- Reliance Foundry reserves the right to amend design and specifications without prior notice for product improvement.

PARTS LIST					
ITEM	QTY	PART NUMBER	DESCRIPTION	MATERIAL	WEIGHT
1	1	R-9705	Concrete Bollard	Precast Concrete	220 lbs
2	3	rb1536	Steel Rebar 15 mm	Epoxy Coated Steel	3 lbs

RELIANCE FOUNDRY
SINCE 1925

Unit 207, 6450 - 148 Street, Surrey, BC V3S 7G7, Canada
1-888-735-5680 info@reliance-foundry.com
www.reliance-foundry.com

TITLE

**Concrete Bollard
Model R-9705-RB**

SIZE
C

DWG NO
R-9705-RB

REV
B2